

BLACKMER PARTS LIST

PUMP MODEL: NP2E

DISCONTINUED MODEL: NP2C

NOTE: "E" model suffix indicates FKM replaces Buna-N as the standard elastomer.
 (See Instructions ~~105-A00~~ or 185/F for Installation, Operation and Maintenance)

Section 103
 Effective July 2001
 Replaces 185/F3 June95

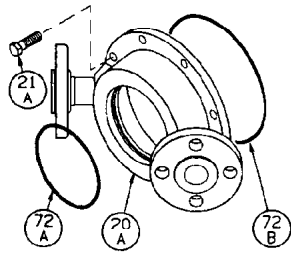

DIN JACKET ADAPTER

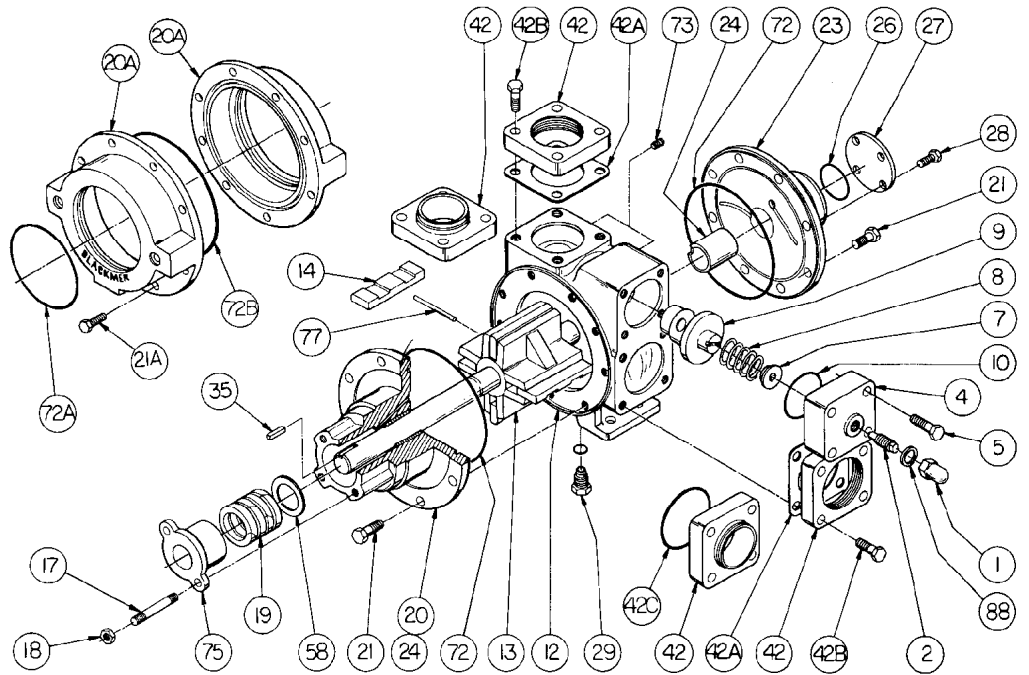

Re. Jacketed Pumps:
 Replacement of either the head or jacket requires the use of the 1 piece head/jacket used on the NP2F.

Ref. No.	Description	Parts per Pump	Part No.	Ref. No.	Description	Parts per Pump	Part No.
1	Cap - Relief Valve (R/V)	1	411452	14	Vane - EC Cast Iron	4	093923
2	Adjusting Screw - R/V	1	431401		Vane - EC Bronze	4	093924
4	Cover - R/V (Std.)	1	411469	20	Head & Bushing Asy. - Inboard	1	031468
	Cover - R/V ¹		411468	20A	SAE Heating Jacket	0 - 2	031470
5	Capscrew - R/V Cover (Std.)	4	920316		Din Heating Jacket/Adapter Asy.		891459
	Capscrew - R/V Cover ¹		920401	21	Capscrews - Head	16	920331
7	Spring Guide - R/V	1	423955	21A	Capscrews - Heating Jacket	0 - 16	920369
8	Spring - R/V (36-50 psi)	1	471415	23	Head & Bushing Asy. - Outboard	1	031469
	Spring - R/V (51-75 psi)		471420	24	Sleeve Bearing	2	161400
	Spring - R/V (76-110 psi)		471425	26	O-Ring - Bearing Cover (FKM) (Std.)	1	702209
	Spring - R/V (111-150 psi)		471428		O-Ring - Bearing Cover (PTFE)	1	702126
	Spring - R/V (151-200 psi) ¹		471400	27	Bearing Cover	1	041400
	SS Spring - R/V (36-50 psi)		471417	28	Capscrews - Bearing Cover	4	920291
	SS Spring - R/V (51-75 psi)		471418	29	Pipe Plug Asy. ² (SAE # 6) (FKM) (Std.)	1	908212
	SS Spring - R/V (76-110 psi)		471427		Pipe Plug Asy. ² (SAE # 6) (PTFE)	1	908213
	SS Spring - R/V (111-150 psi)		471429	35	Key - Shaft	1	909160
	SS Spring - R/V (151-200 psi) ¹		471468	42	Flange - 2" NPT (Std.) ⁴	2	651411
9	Valve - R/V (Std.)	1	451417	42A	Gasket - NPT Flange (Comp.) (Std.) ⁴	2	381421
	Valve - R/V (Nickel Plated)		451415	42B	Capscrew - Flange	8	920351
10	O-Ring - R/V Cover (FKM) (Std.)	1	702212	72	O-Ring - Head (FKM) (Std.)	2	702045
	O-Ring - R/V Cover (PTFE)		702213		O-Ring - Head (PTFE)	2	702081
12	Cylinder (Std.)	1	021403	72A	O-Ring (Small) - Jacket (FKM) ³	0 - 2	701968
	Cylinder w/ Drain (Ductile Iron) ²		021411		O-Ring (Small) - Jacket (EPR) ³	0 - 2	702248
13	Rotor & Shaft (Std.)	1	261468	72B	O-Ring (Large) - Jacket (FKM) ³	0 - 2	702045
	Rotor & Shaft (Ext. Length)		261469		O-Ring (Large) - Jacket (EPR) ³	0 - 2	702252
14	Vane - Duravane (Std.)	4	091419	73	Gage Plug	2	908198
	Vane - Laminate		091427	77	Push Rods	2	123905
	Vane - EC Laminate		091429	88	Gasket - R/V Cap	1	701981

¹Optional High Pressure Relief Valve - parts must be used as a group (includes p/n's 411468, 920373, and either 471400 or 471468). ²SAE Plug standard with ductile iron cylinder (p/n 021411) and cast iron cylinder w/drain (p/n 021402). ³For hot oil circulation use FKM O-Rings; For steam circulation use EPR O-Rings ⁴See backside for Flange Options. EC = Extra-Clearance SS = Stainless Steel
 Keep this parts list with Installation, Operation and Maintenance Instructions.

PACKING - STANDARD

Ref. No.	Part Name	Parts Per Pump	Part No.
17	Stud - Packing Follower	2	921450
18	Nut - Packing Follower Stud	2	922428
19	Packing Set	1	321400
58	Pack Washer	1	351207
75	Packing Follower	1	141468

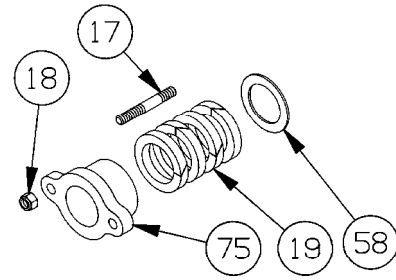

LIP SEAL - OPTIONAL

Ref. No.	Part Name	Parts Per Pump	Part No.
16	Capscrew - Follower	2	920295
75	Seal Follower	1	141468
152	Lip Seal Assembly (To 500°F)	1	702244
152D	Wave Spring	1	321401

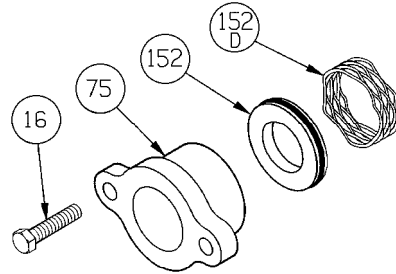

NOTE: A Commercial Mechanical Seal (cartridge type) can be used in place of packing or lip seals. Consult mechanical seal manufacturer for more information.

SHAFT SUPPORT BEARING* - OPTIONAL

Ref. No.	Part Name	Parts Per Pump	Part No.
See Below	Shaft Support Bearing Kit	See Below	891465
106	Bearing Housing	1	651414
106A	Locknut - Bearing Housing	4 - 6	922428
106B	Bearing & Collar Assembly	1	903137
106C	Cover - Bearing Housing	1	651409
106D	Stand Off - Bearing Support (for use with packing)	2	651402
	Stand Off - Bearing Support (for use with mechanical seal)	4	651403
106E	Stud - Bearing Support	4	921480
106F	Washer - Locknut	4	909665
106G	Bearing & Housing Assembly	—	631404

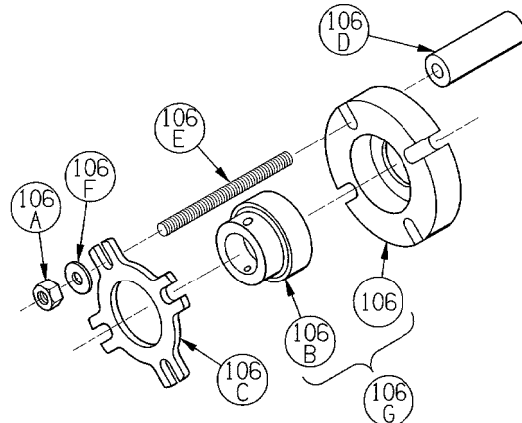

* Shaft Support Bearing is designed for use with Extended Length Rotor & Shaft - p/n 261469.

FLANGE OPTIONS

Ref. No.	Part Name	Parts Per Pump	Part No.
42	Flange - 2" Weld (shown on front)	0 - 2	654405
	Flange - DIN 50		651418
	Flange - ANSI 2"		651417
42C	O-Ring - Flange (FKM)	0 - 2	701921
	O-Ring - Flange (PTFE)		702056

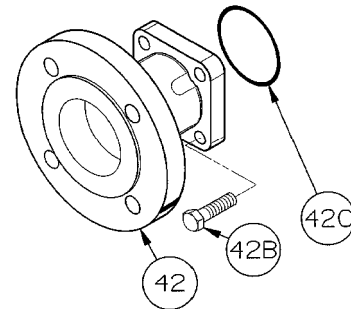

DIN / ANSI FLANGE