

BLACKMER POWER PUMPS

INSTALLATION OPERATION AND MAINTENANCE INSTRUCTIONS

MODELS: LGF1E, LGB1E, LGF1PE, LGB1PE

960400

INSTRUCTIONS NO. 501-A00

Section Effective Replaces	501 Apr 2011 Aug 2010
----------------------------	-----------------------------



SAFETY DATA



This is a SAFETY ALERT SYMBOL.

When you see this symbol on the product, or in the manual, look for one of the following signal words and be alert to the potential for personal injury, death or major property damage



Warns of hazards that **WILL** cause serious personal injury, death or major property damage.



Warns of hazards that **CAN** cause serious personal injury, death or major property damage.



Warns of hazards that **CAN** cause personal injury or property damage.

NOTICE:

Indicates special instructions which are very important and must be followed.

TABLE OF CONTENTS

Page

PUMP DATA

Technical Data	2
Initial Pump Start Up Information.....	2

INSTALLATION

Pre-Installation Cleaning	3
Location and Piping.....	3
Pump Relief Valve and Bypass valve	3
Check Valves	4
Mounting	4
Coupling Alignment	4
Pump Rotation.....	4
To Change Pump Rotation	4

OPERATION

Pre-Start Up Check List.....	5
Start Up Procedures.....	5
Relief Valve Setting and Adjustment	5

MAINTENANCE

Strainers.....	6
Lubrication.....	6
Vane Replacement.....	7
Pump Disassembly	7
Parts Replacement.....	8
Pump Assembly	8

TROUBLE SHOOTING	11
-------------------------------	----

Numbers in parentheses following individual parts indicate reference numbers on Blackmer Parts List No. 501-A01.

Blackmer pump manuals and parts lists may be obtained from Blackmer's website (www.blackmer.com) or by contacting Blackmer Customer Service.

NOTICE:

Blackmer liquefied gas pumps **MUST** only be installed in systems which have been designed by qualified engineering personnel. The system **MUST** conform to all applicable local and national regulations and safety standards.

This manual is intended to assist in the installation and operation of the Blackmer liquefied gas pumps, and **MUST** be kept with the pump.

Blackmer liquefied gas pump service shall be performed by qualified technicians **ONLY**. Service shall conform to all applicable local and national regulations and safety standards.

Thoroughly review this manual, all Instructions and hazard warnings, **BEFORE** performing any work on the Blackmer liquefied gas pumps.

Maintain **ALL** system and Blackmer liquefied gas pump operation and hazard warning decals.

SAFETY DATA

⚠ WARNING



Hazardous machinery can cause serious personal injury.

Failure to disconnect and lockout electrical power or engine drive before attempting maintenance can cause severe personal injury or death

⚠ WARNING



Hazardous voltage. Can shock, burn or cause death.

Failure to disconnect and lockout electrical power before attempting maintenance can cause shock, burns or death

⚠ WARNING



Hazardous pressure can cause serious personal injury or property damage

Disconnecting fluid or pressure containment components during pump operation can cause serious personal injury or property damage.

⚠ WARNING



Hazardous pressure can cause serious personal injury or property damage

Failure to relieve system pressure prior to performing pump service can cause serious personal injury or property damage. Systems with meters will still be pressurized even after the hose is emptied

⚠ WARNING



Hazardous or toxic fluids can cause serious injury.

If pumping hazardous or toxic fluids, system must be flushed and decontaminated, inside and out, prior to performing service or maintenance

⚠ WARNING



Do not operate without guard in place

Operation without guards in place can cause serious personal injury, major property damage, or death.

PUMP DATA

PUMP IDENTIFICATION

A pump Identification tag, containing the pump serial number, I.D. number, and model designation, is attached to each pump. It is recommended that the data from this tag be recorded and filed for future reference. If replacement parts are needed, or if information pertaining to the pump is required, this data must be furnished to a Blackmer representative.

TECHNICAL DATA

Maximum Pump Speed	1,750 RPM
Maximum Operating Temperature	240°F (115°C)
Maximum Differential Pressure	125 psi (8.6 Bar)
Maximum Working Pressure	350 psi (24.1 Bar)

- Technical Data is for standard materials of construction. Consult Blackmer Material Specs for optional materials of construction.
- These pumps are listed by Underwriters' Laboratories for liquefied petroleum gas and NH₃ service.

INITIAL PUMP START UP INFORMATION

Model No.: _____
Serial No.: _____
ID No.: _____
Date of Installation: _____
Inlet Gauge Reading: _____
Discharge Gauge Reading: _____
Flow Rate: _____

INSTALLATION

NOTICE:

Blackmer pumps must only be installed in systems designed by qualified engineering personnel. System design must conform with all applicable regulations and codes and provide warning of all system hazards.

NOTICE:

This pump shall be installed in accordance with the requirements of NFPA 58 all applicable local, state and national regulations.



- ⚠ Install, ground and wire to local and National Electrical Code requirements.
- ⚠ Install an all-leg disconnect switch near the unit motor.
- ⚠ Disconnect and lockout electrical power before installation or service
- ⚠ Electrical supply **MUST** match motor nameplate specifications.

⚠ Motors equipped with thermal protection automatically disconnect motor electrical circuit when overload exists. Motor can start unexpectedly and without warning.

PRE-INSTALLATION CLEANING

NOTICE:

New pumps contain residual test fluid and rust inhibitor. If necessary, flush pump prior to use.

Foreign matter entering the pump WILL cause extensive damage. The supply tank and intake piping MUST be cleaned and flushed prior to pump installation and operation.

LOCATION AND PIPING

Pump life and performance will be significantly reduced when installed in an improperly designed system. Before starting the layout and installation of the piping system, review the following suggestions:

1. Locate the pump as near as possible to the source of supply to avoid excessive inlet pipe friction.
2. The inlet line should be at least as large as the intake port on the pump. It should slope downward to the pump, and should not contain any upward loops. Eliminate restrictions such as sharp bends; globe valves, unnecessary elbows, and undersized strainers.
3. A strainer must be installed in the inlet line to protect the pump from foreign matter. The strainer should be located at least 24" (0.6m) from the pump, and have a net open area of at least four times the area of the intake piping. Strainers must be cleaned regularly to avoid pump starvation.
4. The intake and discharge piping system must be free of all leaks.
5. Expansion joints, placed at least 36" (0.9m) from the pump, will compensate for expansion and contraction of the pipes. Contact the flexible connector/hose manufacturer for required maintenance/care and design assistance in their use.
6. ALL piping and fittings MUST be properly supported to prevent any piping loads from being placed on the pump.

7. Install pressure gauges in the NPT ports provided in the pump casing to check pump performance at start up.
8. Check alignment of pipes to pump to avoid strains, which might later cause misalignment. See Figure 2. Unbolt flanges or break union joints. Pipes should not spring away or drop down. After pump has been in operation for a week or two, completely recheck alignment.

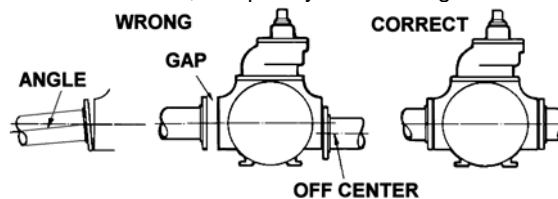

Figure 2

9. The external bypass line should be 1/2" (12.7 mm) diameter pipe and can be piped back to either the liquid or vapor section of the tank. See Figure 3
10. The use of a vapor return line will speed up delivery by preventing pressure build up at the receiving tank and pressure reduction in the supply tank.
11. Keeping the liquefied gas systems full of liquid, even when idle, will keep the O-rings from changing shape, shrinking or super cooling. Evaporation of liquefied gas leaves an abrasive powder on the surface which can cause wear to the pump, meter, and seals.

COMBINATION PUMP RELIEF VALVE AND BACK-TO-TANK BYPASS VALVE

The built-in spring loaded pump relief valve on the LG1 pump models has a dual purpose. The valve provides an external bypass back to the tank to provide relief of excess pressure. The valve also will act as an internal relief valve recirculating fluid within the pump to provide relief of excess pressure if the separate back-to-tank line is closed. See Figure 3. Refer to "Relief Valve Setting and Adjustment" for proper valve setting and adjustment procedure.

Figure 3
Bypass Valve
Mounting

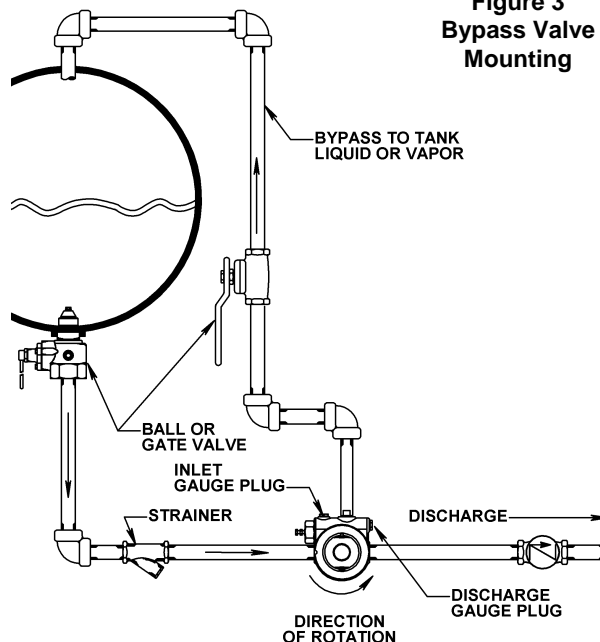

INSTALLATION

CHECK VALVES

The use of check valves or foot valves in the supply tank is not recommended with self-priming, positive displacement pumps.

If the possibility of liquid backflow exists when the pump is off, a check valve in the pump discharge piping is recommended because the pump can motor in the reverse rotation and create undue stress on all attached components. Never start a pump when it is rotating in the reverse rotation as the added starting torque can damage the pump and related equipment.

PUMP MOUNTING

A solid foundation reduces noise and vibration, and will improve pump performance. On permanent installations it is recommended the pumping unit be secured by anchor bolts as shown in Figure 4. This arrangement allows for slight shifting of position to accommodate alignment with the mounting holes in the base plate.

For new foundations, it is suggested that the anchor bolts be set in concrete. When pumps are to be located on existing concrete floors, holes should be drilled into the concrete to hold the anchor bolts.

When installing units built on channel or structural steel type bases, use care to avoid twisting the base out of shape when anchor bolts are tightened. Shims should be used under the edges of the base prior to tightening of the anchor bolts to prevent distortion.

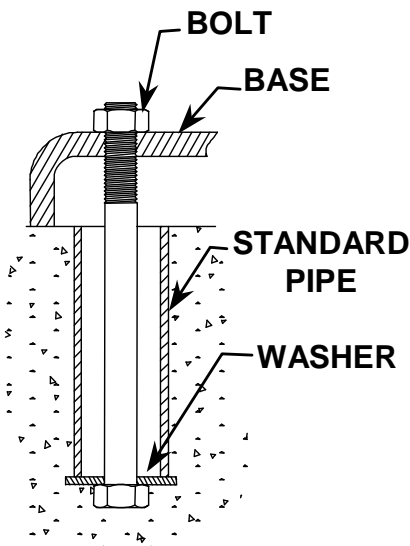

Figure 4 – Pipe Type Anchor Bolt

COUPLING ALIGNMENT

The pump must be directly coupled to a gear reducer and/or driver with a flexible coupling. Verify coupling alignment after installation of new or rebuilt pumps. Both angular and parallel coupling alignment MUST be maintained between the pump, gear, motor, etc. in accordance with manufacturer's instructions. See Figure 5.

1. Parallel alignment: The use of a laser alignment tool or dial indicator is preferred. If a laser alignment tool or dial indicator is not available, use a straightedge. Turn both shafts by hand, checking the reading through one complete revolution. Maximum offset should be less than .005" (0.127 mm).
2. Angular alignment: Insert a feeler gauge between the coupling halves. Check the spacing at 90° increments around the coupling (four checkpoints). Maximum variation should not exceed 0.005" (0.127 mm). Some laser alignment tools will check angular alignment as well.
3. Replace the coupling guards after setting alignment.

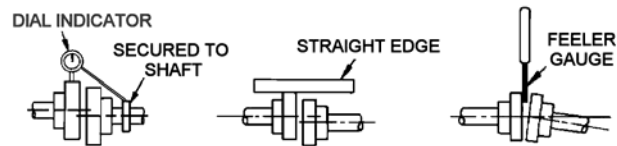
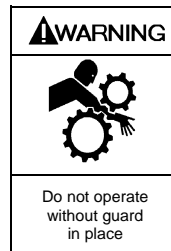

Figure 5 – Coupling Alignment



Operation without guards in place can cause serious personal injury, major property damage, or death.

Do not operate without guard in place

PUMP ROTATION

NOTICE:

Confirm correct pump rotation by checking the pump rotation arrows respective to piping flow direction. Do not operate the pump in reverse rotation to reverse the direction of flow.

1. Determine direction of flow where the pump will be installed.
2. Confirm pump is installed in piping so that the flow will pass through the pump from inlet to outlet. The inlet of the pump has "INLET" cast in the cylinder and the outlet has "OUTLET" cast in the cylinder.
3. Briefly "jog" pump with pump driver. Check rotation of pump driver with respect to rotation arrow on pump.

TO CHANGE PUMP ROTATION

Current 6-vane models: To reverse rotation, the pump must be disassembled then reassembled with the shaft on the opposite side of the pump. See the 'Maintenance' section for instructions.

OPERATION

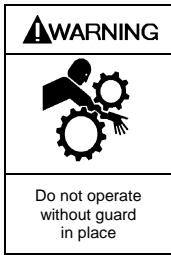

Operation without guards in place can cause serious personal injury, major property damage, or death.

Do not operate without guard in place



Failure to relieve system pressure prior to performing pump service can cause serious personal injury or property damage. Systems with meters will still be pressurized even after the hose is emptied

Hazardous pressure can cause serious personal injury or property damage

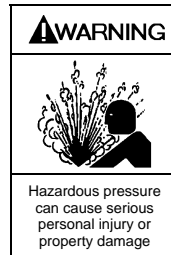

Disconnecting fluid or pressure containment components during pump operation can cause serious personal injury or property damage.

Hazardous pressure can cause serious personal injury or property damage

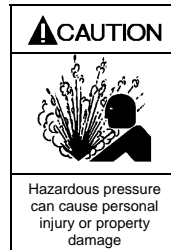

Pumps operating against a closed valve can cause system failure, personal injury and property damage

Hazardous pressure can cause personal injury or property damage

PRE-START UP CHECK LIST

1. Check the alignment of the pipes to the pump. Pipes should be supported so that they do not spring away or drop down when pump flanges or union joints are disconnected.
2. Verify proper coupling alignment.
3. Check the entire pumping system to verify that the proper inlet and discharge valves are fully open, and that the drain valves and other auxiliary valves are closed.
4. Install suction and discharge pressure gauges on the pump in the threaded connections provided. These can be used to check actual suction and discharge conditions after pump start-up.
5. Check the wiring of the motor.
6. Briefly start the pump to verify proper rotation direction.

8. An external bypass valve, if used, must be set at least 25 psi (1.7 bar) lower than the internal pump relief valve.
NOTE: The normal operating pressure must be at least 5 - 15 psi (0.3 -1.0 bar) less than the external bypass valve setting.

NOTE: If the pump is operated with both the discharge line and bypass line closed, the pump will recirculate fluid through the internal relief valve, causing cavitation and excessive wear on the pump. The pressure gauge may also read lower than with normal operation.

START UP PROCEDURES

NOTICE:

Consult the "General Pump Troubleshooting" section of this manual if difficulties during start up are experienced.

1. SLOWLY build pressure in the pump.
2. Start the pump. Priming should occur within one minute.
3. Check the suction and discharge pressure gauges to see if the pump is operating within the expected conditions.
4. Check for leakage from the piping and equipment.
5. Check for excessive noise, vibration or overheating of the pump, reducer, and motor.
6. If possible, check the flow rate.
7. With the manual valve in the bypass line OPEN, check the pressure setting of the relief valve by slowly closing a valve in the discharge line and reading the pressure gauge. As the valve in the discharge line is closed, the pump discharge pressure will rise to a maximum value, then drop back slightly. Use the maximum pressure to determine the valve setting. This pressure should be 10 - 20 psi (0.7 -1.4 bar) higher than the maximum system operating pressure. If adjustments need to be made, refer to the "Relief Valve Setting and Adjustment" section of this manual.

RELIEF VALVE SETTING AND ADJUSTMENT

The relief valve pressure setting is marked on a metal tag attached to the valve cover. Generally, the relief valve should be set at least 10 - 20 psi (0.7 - 1.4 Bar) higher than the operating pressure, or any external bypass valve setting.

DO NOT adjust the relief valve pressure setting while the pump is in operation.

1. **To INCREASE the pressure setting**, loosen the locknut, and turn the adjusting screw *inward*, or clockwise. Retighten the locknut
2. **To DECREASE the pressure setting**, loosen the locknut, and turn the adjusting screw *outward*, or counterclockwise. Retighten the locknut

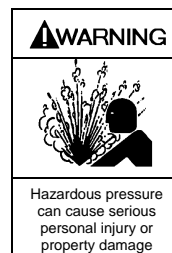

Incorrect settings of the pressure relief valve can cause pump component failure, personal injury, and property damage.

Hazardous pressure can cause serious personal injury or property damage

MAINTENANCE:

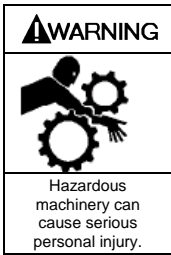

Failure to disconnect and lockout electrical power or engine drive before attempting maintenance can cause severe personal injury or death

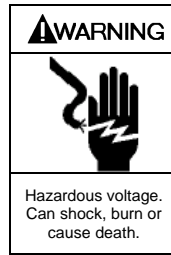

Failure to disconnect and lockout electrical power before attempting maintenance can cause shock, burns or death



Disconnecting fluid or pressure containment components during pump operation can cause serious personal injury or property damage.

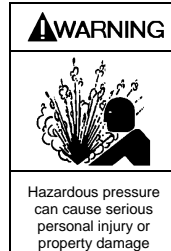

Failure to relieve system pressure prior to performing pump service can cause serious personal injury or property damage. Systems with meters will still be pressurized even after the hose is emptied

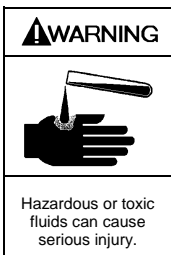

If pumping hazardous or toxic fluids, system must be flushed and decontaminated, inside and out, prior to performing service or maintenance

NOTICE:

Maintenance shall be performed by qualified technicians only. Follow the appropriate procedures and warnings as presented in this manual.

SCHEDULED MAINTENANCE

STRAINERS

Strainers must be cleaned regularly to avoid pump starvation. Schedule will depend upon the application and conditions.

LUBRICATION

NOTICE:

To avoid possible entanglement in moving parts do not lubricate pump bearings or any other parts while pump is running

Pump bearings should be lubricated every one to twelve weeks (AT MINIMUM), depending on the application, and operating conditions.

Recommended Grease:

Mobil® - Mobilgrease XHP222,
Exxon® - RONNEX MP Grease,
or equivalent.

Greasing Procedure:

1. Remove the grease relief fittings (76A) from the bearing cover (27) and mounting bracket (108 or 108B).
2. **SLOWLY** apply grease with a hand gun until grease begins to escape from the grease relief fitting port.
3. Replace the grease relief fittings (76A).

DO NOT overgrease pump bearings. While it is normal for some grease to escape from the grease tell-tale hole after lubrication, excessive grease on pumps equipped with mechanical seals can cause seal failure.

MAINTENANCE:

VANE REPLACEMENT

NOTICE:

Maintenance shall be performed by qualified technicians only. Following the appropriate procedures and warnings as presented in manual.

NOTE: The numbers in parentheses following individual parts indicate reference numbers on the Pump Parts List.

1. Drain and relieve pressure from the pump and system as required.
2. If the pump shaft is protruding through the cylinder (12), remove the head assembly from the pump according to steps 4 - 8 in the "Pump Disassembly" section of this manual. If the pump shaft is protruding through the head (20), remove the entire pump from the mounting bracket (108 or 108B) (See Step 3 in "Pump Disassembly") then remove the head assembly from the pump according to steps 5 - 8 in the "Pump Disassembly" section of this manual.
3. Turn the shaft by hand until a vane (14) comes to the top (12 o'clock) position of the rotor. Remove the vane.
4. Install a new vane (14), ensuring that the relief groove is facing toward the direction of rotation. See Figure 6.
5. Repeat steps 3 and 4 until all vanes have been replaced.
6. Reassemble the pump according to the "Pump Assembly" section of this manual.

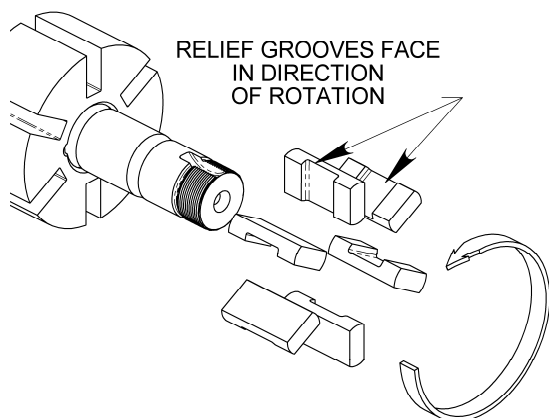

Figure 6 – Vane Replacement

PUMP DISASSEMBLY

NOTICE:

Follow all hazard warnings and instructions provided in the "Maintenance" section of this manual.

NOTE: The numbers in parentheses following individual parts indicate reference numbers on the Pump Parts List.

1. Drain and relieve pressure from the pump and system as required.
2. Loosen the coupling (34) and remove the shaft key (35).
3. Remove the four mounting screws (28A) and remove the entire pump assembly from the bracket mount (108 or 108B).
4. Remove the bearing cover capscrews (28), the bearing cover (27) and gasket (26) Discard the bearing cover gasket.
5. Remove the locknut (24A) and lockwasher (24B) from the shaft end protruding through the head (20):
 - a. Bend up the engaged lockwasher tang and rotate the locknut counterclockwise to remove it from the shaft.
 - b. Slide the lockwasher off the shaft. Inspect the lockwasher for damage and replace as required.
6. Clean the shaft portion protruding through the head thoroughly, making sure the shaft is free of nicks and burrs. This will prevent damage to the mechanical seal when the head assembly is removed.
7. Remove the head capscrews (21) and carefully pry the head (20) away from the cylinder.
8. Slide the head off the shaft. The head O-ring (72), bearing (24), and mechanical seal (153) will come off with the head assembly. Remove and discard the head O-ring.
9. Pull the bearing (24) from the housing in the head.
10. Place a cloth under the seal to prevent damage. Using a blunt instrument, gently push the stationary seat (153B) to remove it from the head. Be careful not to contact the seal faces during removal.
11. Remove and discard the mechanical seal O-rings (153D and 153G).
12. Remove the locknut (24A) and lockwasher (24B) from the shaft end protruding through the cylinder (12):
 - a. Bend up the engaged lockwasher tang and rotate the locknut counterclockwise to remove it from the shaft.
 - b. Slide the lockwasher off the shaft. Inspect the lockwasher for damage and replace as required.
13. Clean the shaft protruding through the cylinder thoroughly, making sure the shaft is free of nicks and burrs.
14. Gently pull the rotor and shaft (13) from the cylinder. While one hand is pulling the shaft, the other hand should be cupped underneath the rotor to prevent the vanes (14) from falling out. Carefully set the rotor and shaft aside.
15. Remove vanes (14) from rotor and shaft (13).
16. Pull the bearing (24) from the cylinder.
17. Place a cloth under the seal to prevent damage. Using a blunt instrument, gently push the stationary seat (153B) to remove it from the head. Be careful not to contact the seal faces during removal.
18. Remove and discard the mechanical seal O-rings (153D and 153G).

MAINTENANCE:

PARTS REPLACEMENT

1. If any of the O-rings have been removed or disturbed during disassembly, they must be replaced with new O-rings.
2. Excessive or continuous leakage from the tell-tale hole in the bearing cover may be an indication of a damaged mechanical seal. If a mechanical seal has been leaking, it is recommended the entire seal be replaced. Refer to "General Pump Troubleshooting" for possible causes of seal leakage.

PUMP ASSEMBLY

Before reassembling the pump, inspect all component parts for wear or damage, and replace as required. Wash out the bearing/seal recess of the head and cylinder and remove any burrs or nicks from the rotor and shaft.

1. Position the pump cylinder (12) with the bearing side up.
2. Apply a small amount of quality O-ring lubricant in the seal and bearing recess of the cylinder to facilitate mechanical seal (153) installation.
3. Insert the seal jacket assembly (153A) into the seal recess of the cylinder with the drive tangs of the jacket inward.
4. With the polished face outward, align the notches of the rotating seal face with the jacket, and install the seal face (153F) and O-ring (153G) into the jacket assembly. After installation, clean the seal face with a clean tissue and alcohol.
5. Clean the polished face of the stationary seat (153B) with a clean tissue and alcohol.
6. Install new O-ring (153D) onto stationary seat (153B).
7. Align the notch in stationary seat (153B) with the anti-rotation pin in the cylinder (12) and insert it into the seal recess with the polished face inward to mate with the rotating face.
8. Hand pack the ball bearing (24) with grease. Refer to "Lubrication" in the Pump Maintenance Section for the recommended grease.
9. Install the bearing (24) into the cylinder recess. The bearing balls should face outward, with the grease shield inward. Ensure that the bearing (24) is fully and squarely seated against the mechanical seal (153).
10. Keep the bearing (24) from falling out of the cylinder (12) by securing with one of the bearing cover capscrews (28) and a washer that will catch the outer ring of the bearing when tightened.
11. Turn the pump cylinder (12) over with the INTAKE port and relief valve to the **right**.
12. Determine which rotation direction the pump should be when installed.
13. Apply a light coating of quality O-ring lubricant to the shaft end to be inserted into the cylinder.
14. Insert the shaft into the cylinder (12). Carefully slide the shaft through the installed mechanical seal (153) and bearing. Align the notch in the rotor with the drive tang on the seal jacket of the mechanical seal. Rotate the shaft to ensure the drive tangs of the mechanical seal are engaged in the notches in the rotor.
15. Install lockwasher (24B) on the shaft protruding through the bearing in the cylinder with the tangs outward. Ensure the inner tang "A" of the lockwasher is engaged in the slot in shaft threads. Bend it slightly, if necessary. (See Figure 8.)
16. Install locknut (24A) onto threads of shaft with the tapered end inward.
17. Tighten the locknut (24A) with a spanner wrench to pull the rotor flat against the back wall of the cylinder. DO NOT overtighten the locknut and bend or shear the inner tang. Adjustment to the locknuts will be made after the head is installed.
18. Insert the vanes (14) into the slots in the rotor, ensuring that the relief groove is facing toward the direction of rotation. See Figure 6
19. Apply a light coating of quality O-ring lubricant in the seal and bearing recess of the head (20) to facilitate mechanical seal (153) installation.
20. Insert the seal jacket assembly (153A) into the seal recess of the head with the drive tangs of the jacket inward.
21. With the polished face outward, align the notches of the rotating seal face with the jacket, and install the seal face (153F) and O-ring (53G) into the jacket assembly.
22. Clean the polished face of the stationary seat (153B) with a clean tissue and alcohol.
23. Install new O-ring (153D) onto stationary seat (153B).
24. Align the notch in stationary seat (153B) with the anti-rotation pin in the head (20). Insert it into the seal recess with the polished face inward to mate with the rotating face.
25. Hand pack the ball bearing (24) with grease. Refer to "Lubrication" in the Pump Maintenance Section for the recommended grease.
26. Install the bearing (24) into the head recess. The bearing balls should face outward, with the grease shield inward. Ensure that the bearing (24) is fully and squarely seated against the mechanical seal (153).
27. Apply a small amount of quality O-ring lubricant to the O-ring groove on the inside face of the head and install a new head O-ring (72) in the groove by laying the O-ring flat and starting in on one side of the groove, stretching ahead with the fingers, as shown in Figure 7.

NOTE:

6 vane pumps may be assembled Right-Hand (Factory Standard) or Left-Hand.

A Right-Hand rotation pump will have the drive end of the shaft (long end) protruding through the cylinder (12) with the bearing cover on the head.

A Left-Hand rotation pump will have the drive end of the shaft (long end) protruding through the head (20) with the bearing cover on the cylinder.

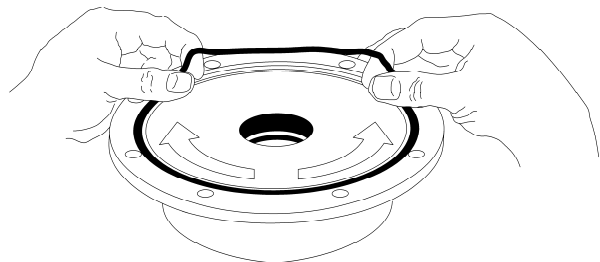

Figure 7 Head O-ring Installation

MAINTENANCE:

28. Apply a light coating of quality O-ring lubricant on the shaft to facilitate head installation.
29. With the tell-tale hole towards the bottom of the pump, carefully install the head assembly (20) over the shaft and against the cylinder (12). Use care not to damage the mechanical seal components. Align the drive tangs of the mechanical seal with the notches in the rotor.
30. Rotate the head (20) to engage the drive tangs of the seal jacket with the slots in the rotor.
31. Install and finger tighten the head capscrews (21). The head capscrews will be fully tightened after the second locknut is installed.
32. Install lockwasher (24B) on the shaft protruding through the bearing in the head with the tangs outward. Ensure the inner tang "A" of the lockwasher is engaged in the slot in shaft threads. Bend it slightly, if necessary. (See Figure 8.)
33. Install locknut (24A) onto threads of shaft with the tapered end inward.
34. Using a keyed coupling half, hold the shaft end and tighten the locknut with a spanner wrench to pull the head against the cylinder. DO NOT overtighten and shear the inner tang of the lockwasher.
35. Uniformly tighten the head capscrews, torquing to 25 lbs ft (34 Nm).
36. Loosen both bearing locknuts (24A).
37. Rotate the shaft to test for binding or tight spots. If the rotor does not turn freely, tap the rim of the head with a soft faced mallet until the correct position is found.
40. Loosen both locknuts (24A) one complete turn.
41. Tighten one locknut (24A) until a slight rotor drag is felt when turning the shaft by hand.
42. Back off the nut the width of one lockwasher tang "B". Secure the nut by bending the closest aligned lockwasher tang into the slot in the locknut. The pump should turn freely when rotated by hand.
43. Tighten the opposite locknut (24A) by hand until it is snug against the bearing (24). Then, using a spanner wrench, tighten the nut the width of one lockwasher tang "B". Tighten just past the desired tang, then back off the nut to align the tang with the locknut slot. Secure the nut by bending the aligned lockwasher tang into the slot in the locknut. The pump should continue to turn freely when rotated by hand.
44. To check adjustment, grasp the nut and washer with fingers and rotate back and forth. If this cannot be done, one or both locknuts are too tight and should be alternately loosened one stop at a time (.001" - 25 microns). Begin by loosening the locknut (24A) adjusted last.
45. Attach the new bearing cover gasket (26) and the bearing cover (27) to the non-driven side of pump with the grease fitting (76) upward. Install and tighten the bearing cover capscrews (28), torquing to 15 lbs ft (20 Nm).
46. Inspect the grease seal (104) in the foot bracket for wear or damage and replace as required. Grease the outside diameter of the grease seal (104) and push it into the bracket (108 or 108B) with the lip inward.
47. Mount the assembled pump on the foot bracket (108 or 108B) with the four mounting screws (28A).
48. Reinstall coupling, shaft key, and coupling guards.
49. Refer to "Pre-Start Up Check List" and "Start Up Procedures" sections of this manual prior to restarting pump operation.

LOCKNUT ADJUSTMENT

It is important that the bearing locknuts (24A) and lockwashers (24B) be installed and adjusted properly. Overtightening locknuts can cause bearing failure or a broken lockwasher tang. Loose locknuts will allow the rotor to shift against the discs (71), causing wear. See Figure 8.

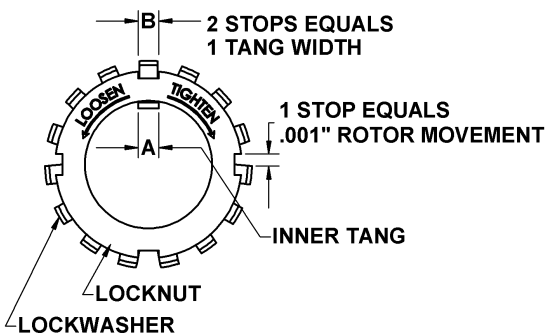

Figure 8— Locknut Assembly

38. On both ends of the pump shaft, install a lockwasher (24B) with the tangs facing outward, followed by a locknut (24A) with the tapered end inward. Ensure the inner tang "A" of the lockwasher is located in the slot in the shaft threads, bending it slightly, if necessary.
39. Tighten both locknuts (24A) to ensure that the bearings (24) are bottomed in the head recess. DO NOT overtighten and bend or shear the lockwasher inner tang.

MAINTENANCE:

RELIEF VALVE ASSEMBLY

1. Insert the valve (9) into the relief valve bore of the casing with the small end inward.
2. Install relief valve disc (9A) into relief valve.
3. Install the relief valve spring (8) in the valve bore.
4. Install new O-ring (4A) on spring guide (7).
5. Install spring guide (7) in valve bore of cylinder, aligning spring (8) on spring guide during assembly.
6. Install new O-ring (10) in O-ring groove in relief valve cap (4).
7. Apply a thin coat of grease on threads of relief valve cap (4) and install in cylinder (12).
8. Screw the relief valve adjusting screw (2) with locknut (3) into the valve cover (4) until it makes contact with the spring guide (7).
9. After the relief valve has been adjusted, tighten the Locknut (3)

NOTICE:

The relief valve setting MUST be tested and adjusted more precisely before putting the pump into service. Refer to "Relief Valve Setting and Adjustment"

10. Refer to "Pre-Start Up Check List" and "Start Up Procedures" sections of this manual prior to restarting pump operation.

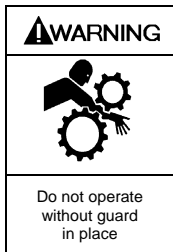

Operation without guards in place can cause serious personal injury, major property damage, or death.

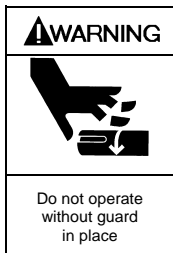

Failure to adjust guards covering all rotating part, allowing only a safe gap, can cause personal injury or death

PUMP TROUBLESHOOTING

NOTICE:

Maintenance shall be performed by qualified technicians only,
following the appropriate procedures and warnings as presented in this manual.

SYMPTOM	PROBABLE CAUSE
Pump Not Priming	<ol style="list-style-type: none">1. Pump not wetted.2. Worn vanes.3. Internal control valve closed.4. Strainer clogged.5. Inlet line or valves clogged or too restrictive.6. Pump vapor-locked.7. Pump speed too low for priming.8. Relief valve partially open, worn or not seating properly.
Reduced Capacity	<ol style="list-style-type: none">1. Pump speed too low.2. Internal control valve not fully open.3. Excessive restriction in the inlet line (i.e.: undersized piping, too many elbows & fittings, clogged strainer, etc.).4. Damaged or worn parts (vanes, cylinder, or rotor).5. Excessive restriction in discharge line causing partial flow through the relief valve.6. Relief Valve worn, set too low, or not seating properly.7. External Bypass Valve set too low.8. Operating without a vapor return line.9. Vanes installed incorrectly (see "Vane Replacement").
Noise	<ol style="list-style-type: none">1. Excessive pressure drop on the pump due to:<ol style="list-style-type: none">a. Undersized or restricted fittings in the inlet line.b. Pump speed too fast.c. Pump too far from fluid source.2. Running the pump for extended periods with a closed discharge line.3. Pump not securely mounted.4. Misalignment of pump, or motor - base mounted pumps.5. Bearings worn or damaged.6. Vibration from improperly anchored piping.7. Bent shaft, or drive coupling misaligned.8. Excessively worn rotor.9. Malfunctioning valve in the system.10. Relief valve setting too low.11. Damaged vanes (see following category).
Damaged Vanes	<ol style="list-style-type: none">1. Foreign objects entering the pump.2. Running the pump dry for extended periods of time.3. Cavitation.4. Excessive heat.5. Hydraulic hammer - pressure spikes.6. Vanes installed incorrectly (see "Vane Replacement").7. Incompatibility with the liquids pumped.
Broken Shaft	<ol style="list-style-type: none">1. Foreign objects entering the pump.2. Relief valve not opening.3. Hydraulic hammer - pressure spikes.4. Pump/driver shaft misalignment.5. Excessively worn vanes or vane slots.
Mechanical Seal Leakage	<ol style="list-style-type: none">1. O-rings not compatible with the liquids pumped.2. O-rings nicked, cut or twisted.3. Shaft at seal area damaged, worn or dirty.4. Ball bearings overgreased.5. Excessive cavitation.6. Mechanical seal faces cracked, scratched, pitted or dirty.
Overload on Motor	<ol style="list-style-type: none">1. Motor Horsepower not sufficient for application.2. Improper wiring and/or low voltage to motor.3. Misalignment4. Excessive pressure or speed.5. Bearing locknuts adjusted improperly.6. Faulty or worn bearings.7. Rotor rubbing against head or cylinder.8. Dirty mechanical seal faces.



Sliding Vane Pumps: 5 to 2200 GPM
 Refined Fuels, Liquefied Gases, Solvents, Process



Stainless Steel Sliding Vane Pumps
 1 to 265 GPM: Acids, Brines, Sugars, Syrups,
 Beer, Beet Juice, Cider, Flavor Extracts, etc.



ProVane® Motor Speed Sliding Vane Pumps
 1 to 100 GPM: Stainless and Ductile Iron
 For low / medium viscosity process applications



Magnetic Drive Pumps
 Stainless Steel: 14 to 215 GPM

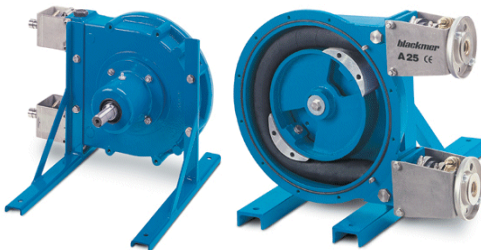

Abaque Peristaltic Hose Pumps
 0.1 to 210 GPM
 High Lift, Solids, Abrasives



Reciprocating Gas Compressors
 Liquefied Gas Transfer, Boosting, Vapor Recovery



Hand Operated Pumps
 Dispensing, Transfer, In-line



Accessories
 Gear Reducers, Bypass Valves, Strainers

Visit www.blackmer.com for complete information on all Blackmer products



1809 Century Avenue, Grand Rapids, Michigan 49503-1530 U.S.A.
 Telephone: (616) 241-1611 • Fax: (616) 241-3752
 E-mail: blackmer@blackmer.com • Internet Address: www.blackmer.com